

6FM100Z-X 12V 100Ah(10hr)

The rechargeable batteries are lead-lead dioxide systems. The dilute sulfuric acid electrolyte is absorbed by separators and plates and thus immobilized. Should the battery be accidentally overcharged producing hydrogen and oxygen, special one-way valves allow the gases to escape thus avoiding excessive pressure build-up. Otherwise, the battery is completely sealed and is, therefore, maintenance-free, leak proof and usable in any position.



Battery Construction

Component	Positive plate	Negative plate	Container	Cover	Safety valve	Terminal	Separator	Electrolyte
Raw material	Lead dioxide	Lead	ABS	ABS	Rubber	Copper	Fiberglass	Sulfuric acid

General Features

- Absorbent Glass Mat (AGM) technology for efficient gas recombination of up to 99% and freedom from electrolyte maintenance or water adding.
- Not restricted for air transport-complies with IATA/ICAO Special Provision A67.
- UL-recognized component.
- Can be mounted in any orientation.
- Computer designed lead, calcium tin alloy grid for high power density.
- Long service life, float or cyclic applications.
- Maintenance-free operation.
- Low self discharge.

Dimensions and Weight

Length(mm / inch)	330 / 12.99
Width(mm / inch)	171 / 6.73
Height(mm / inch)	215 / 8.46
Total Height(mm / inch)	220 / 8.66
Approx. Weight(Kg / lbs)	30 / 66.1

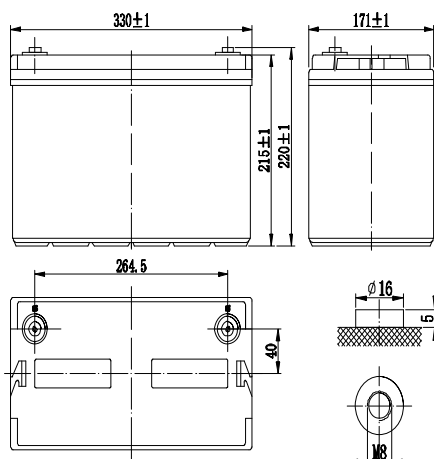

Performance Characteristics

Nominal Voltage	12V
Number of cell	6
Design Life	10 years
Nominal Capacity 77°F(25°C)	
20 hour rate (5.25A, 10.8V)	105Ah
10 hour rate (10.0A, 10.8V)	100Ah
5 hour rate (17.4A, 10.5V)	87.0Ah
3 hour rate (26.6A, 10.5V)	79.8Ah
1 hour rate (65.2A, 9.6V)	65.2Ah
Internal Resistance	
Fully Charged battery 77°F(25°C)	≤ 5.7mOhms
Self-Discharge	
3% of capacity declined per month at 20°C(average)	
Operating Temperature Range	
Discharge	-20~60°C
Charge	-10~60°C
Storage	-20~60°C
Max. Discharge Current 77°F(25°C)	900A(5s)
Short Circuit Current	2100A
Charge Methods: Constant Voltage Charge 77°F(25°C)	
Cycle use	2.40-2.45VPC
Maximum charging current	30A
Temperature compensation	-30mV/°C
Standby use	2.20-2.30VPC
Temperature compensation	-20mV/°C

Discharge Constant Current (Amperes at 77°F25°C)

End Point Volts/Cell	10min	15min	30min	45min	1h	3h	5h	10h	20h
1.60V	220	180	105	78.9	65.2	27.6	18.9	10.4	5.46
1.65V	212	173	101	77.1	61.6	27.4	18.2	10.3	5.42
1.70V	192	159	93.6	71.5	60.6	26.9	17.9	10.2	5.35
1.75V	180	148	90.7	69.9	59.6	26.6	17.4	10.1	5.30
1.80V	168	139	88.7	68.6	56.5	25.1	17.1	10.0	5.25

Discharge Constant Power (Watts at 77°F25°C)

End Point Volts/Cell	10min	15min	30min	45min	1h	2h	3h	5h	20h
1.60V	376	311	194	147	122	69.7	52.3	35.6	10.8
1.65V	364	306	183	143	116	66.9	50.7	35.2	10.7
1.70V	346	290	178	134	112	65.9	50.4	34.8	10.6
1.75V	339	285	173	131	109	63.7	48.6	34.2	10.5
1.80V	316	271	167	128	102	61.7	48.0	33.8	9.97

(Note)The above characteristics data are average values obtained within three charge/discharge cycles not the minimum values.

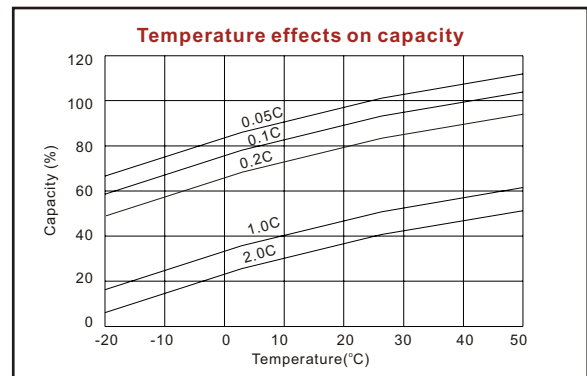
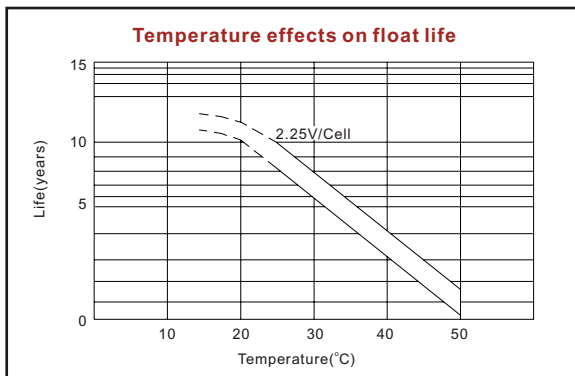
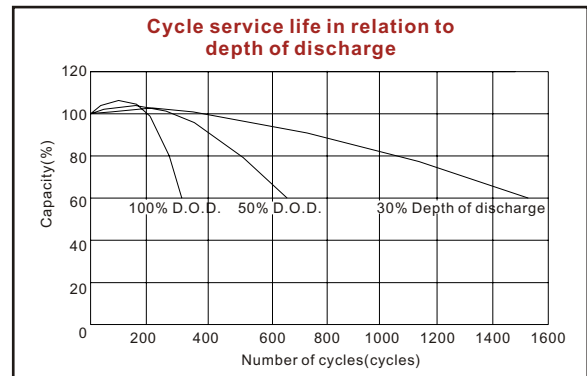
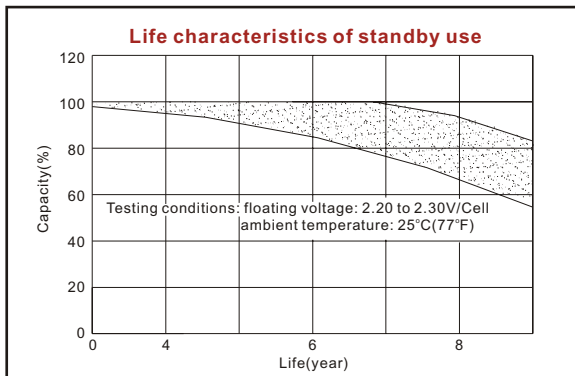
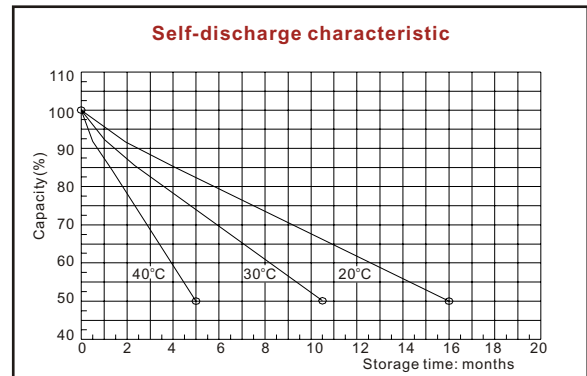
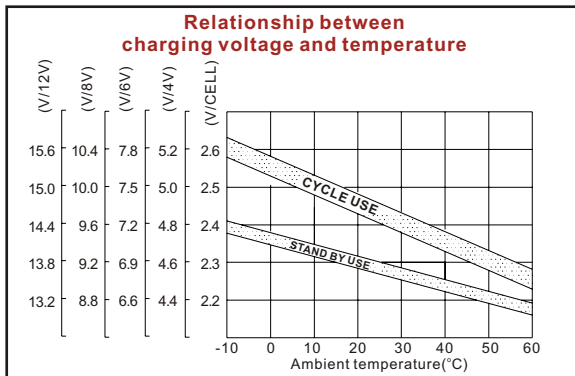
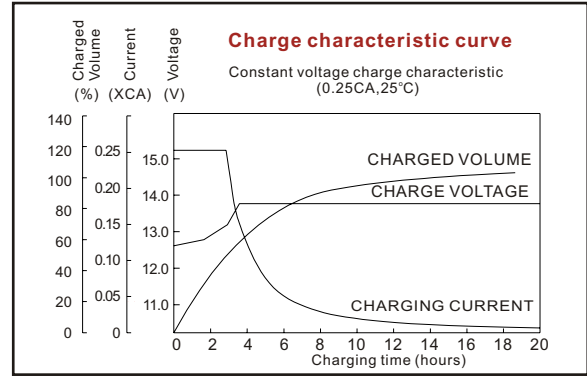
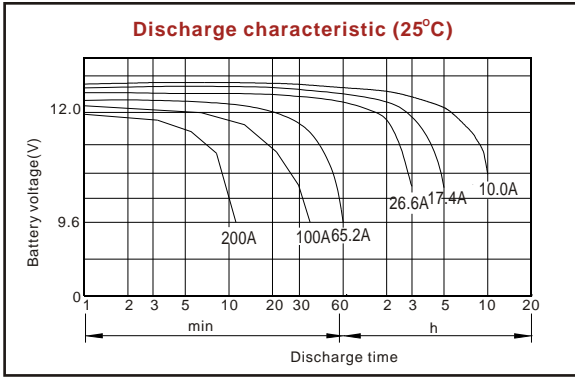

ISO9001:2008

MH25860

G4M19906-9202-E-16

www.vision-batt.com

Shenzhen Center Power Tech. Co., Ltd.
 Center Power Industrial Park, Tongfu Industrial District Dapeng Town, 518120 Shenzhen, China
 Tel: (+86-755) 8431 8088 Fax: (+86-755) 8431 8038 E-mail: sales@vision-batt.com